

LOT 80
voorgevel (schaal 1/50)

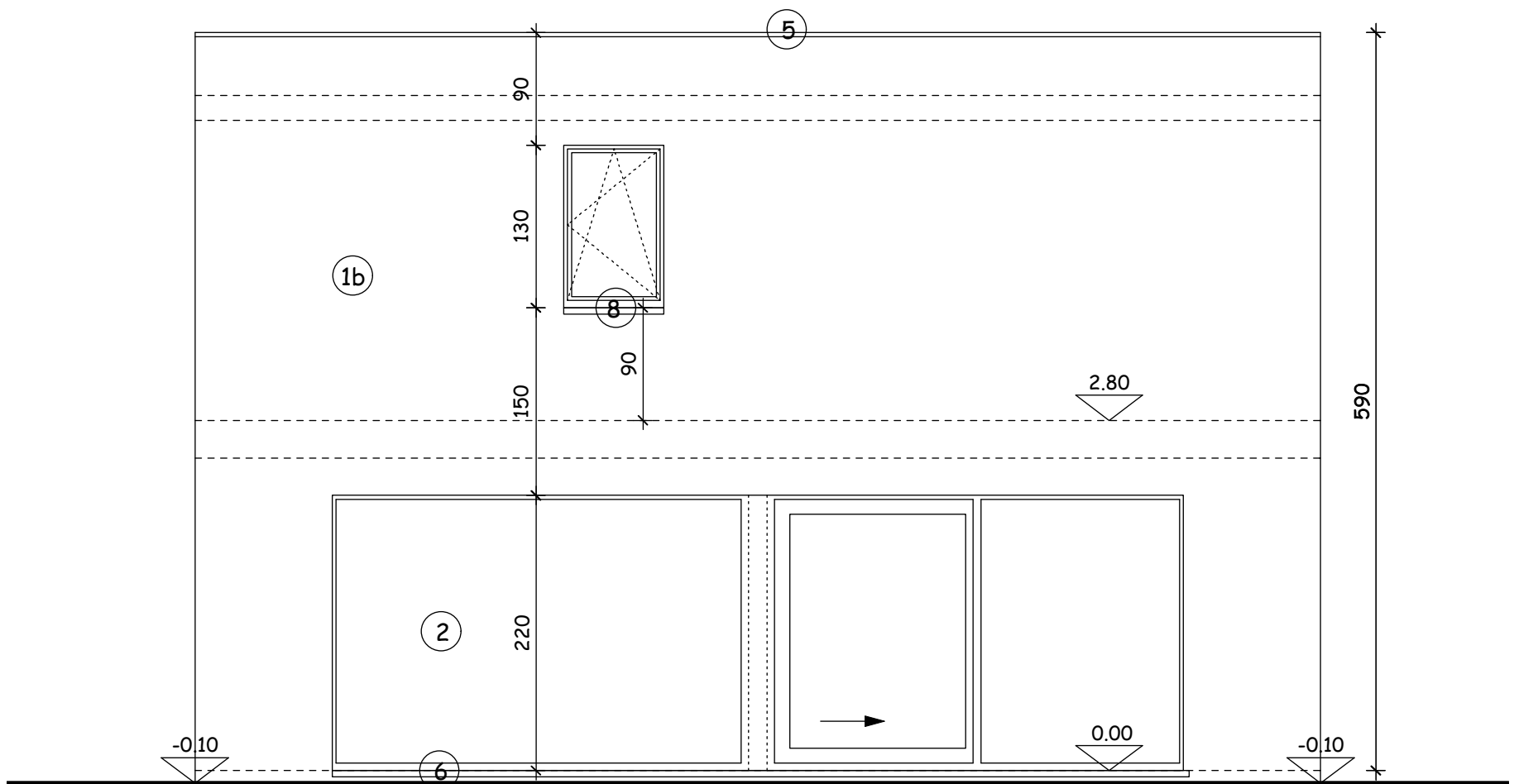

LOT 80
achtergevel (schaal 1/50)

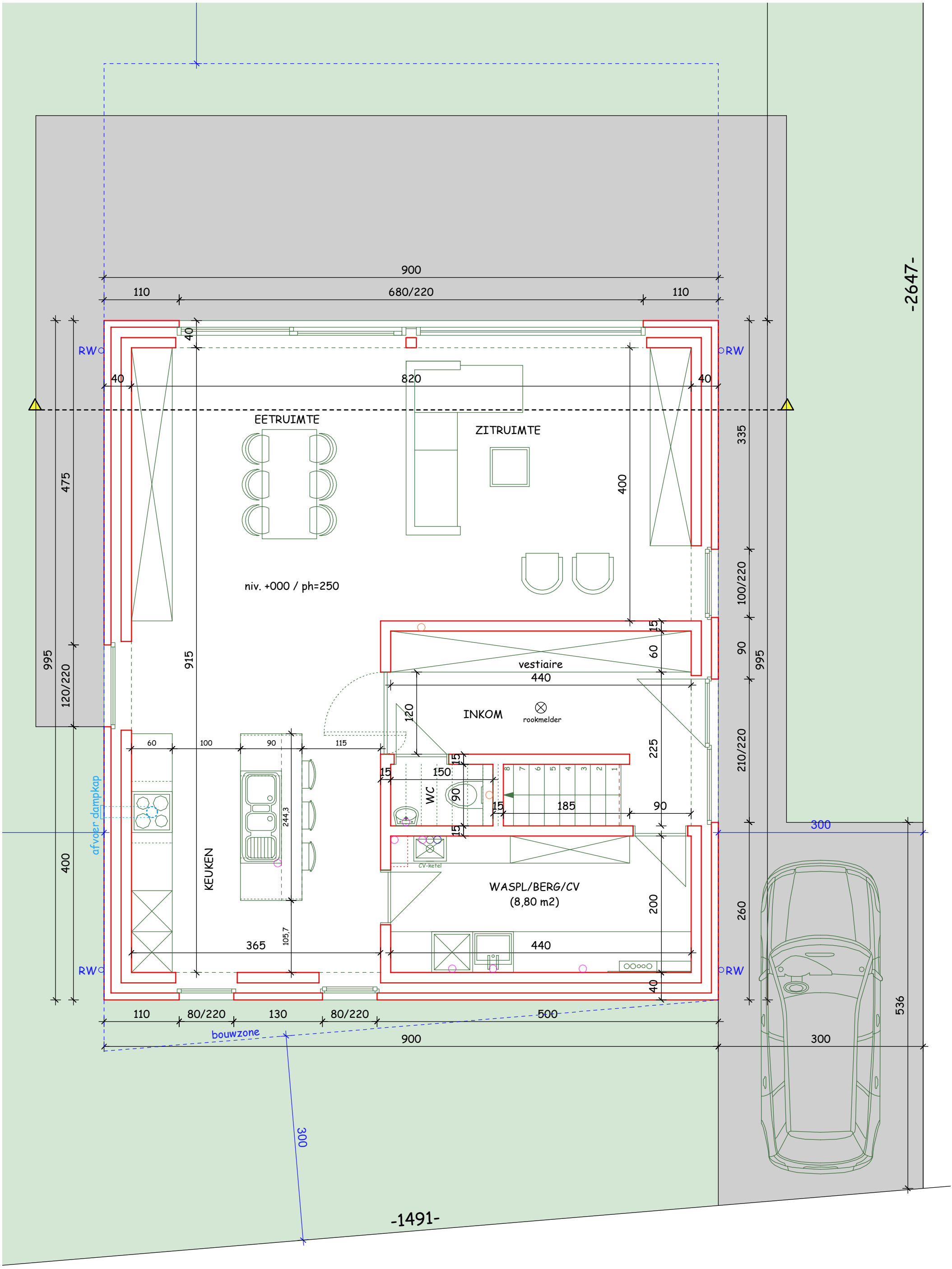

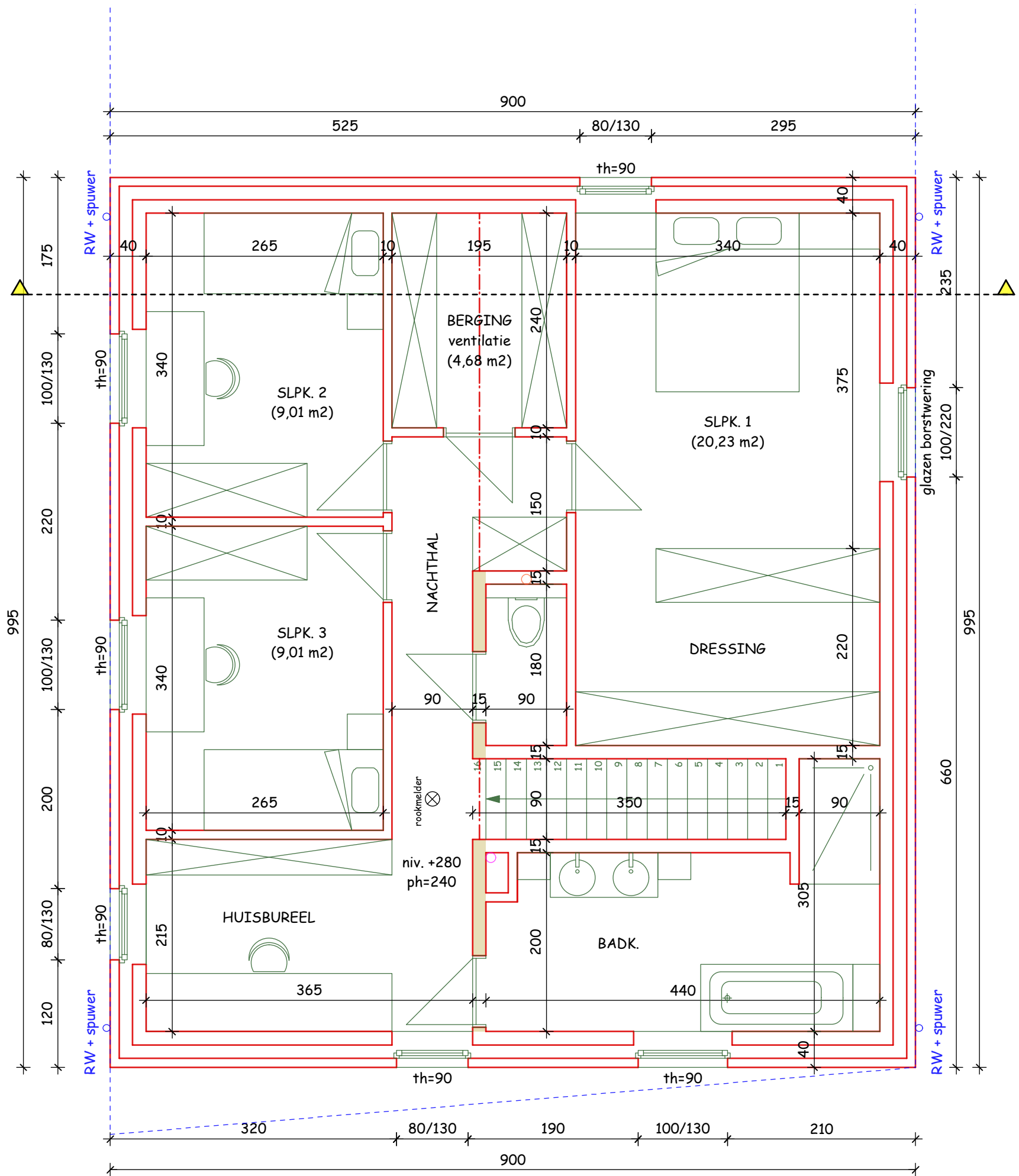

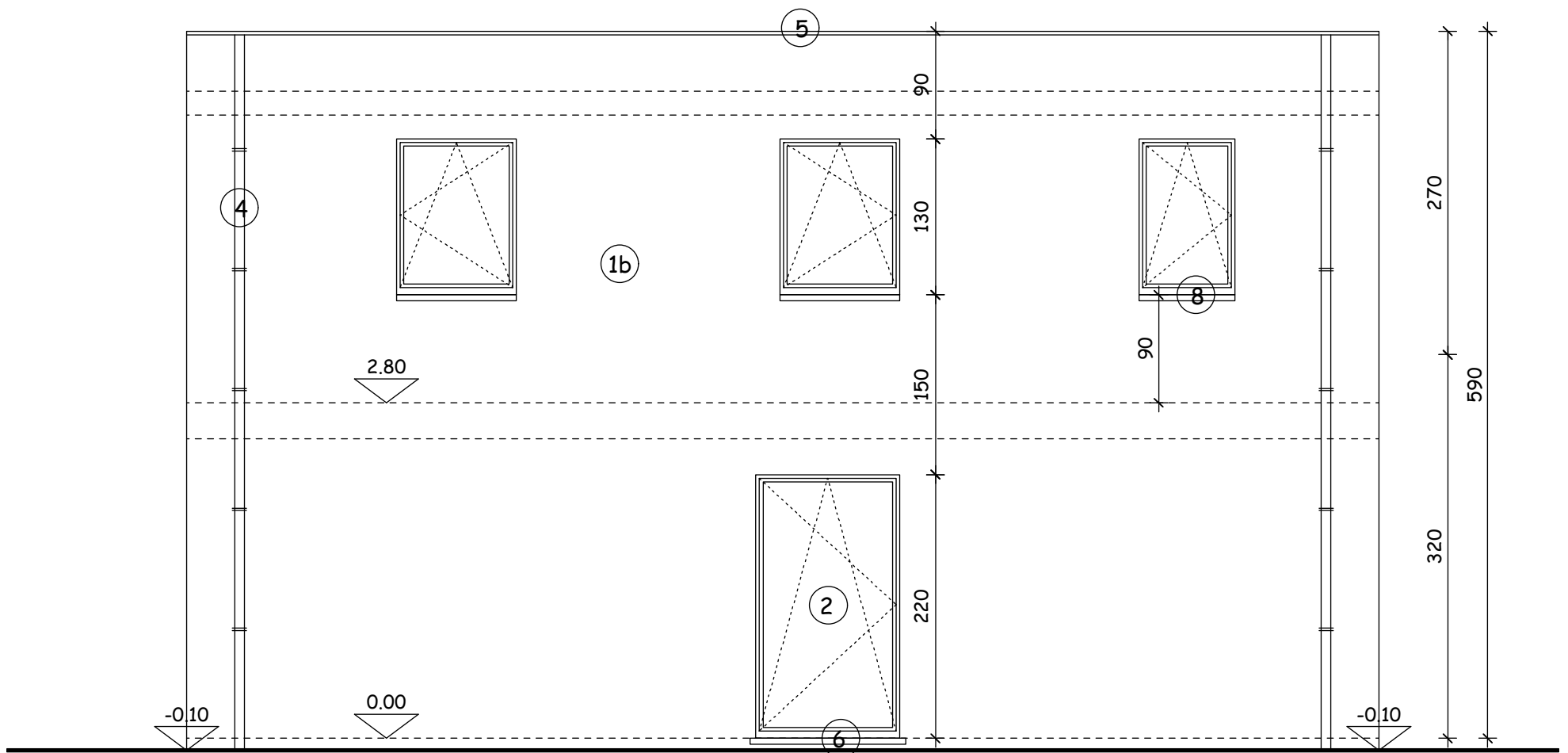

LOT 80
zijgevel links (schaal 1/50)

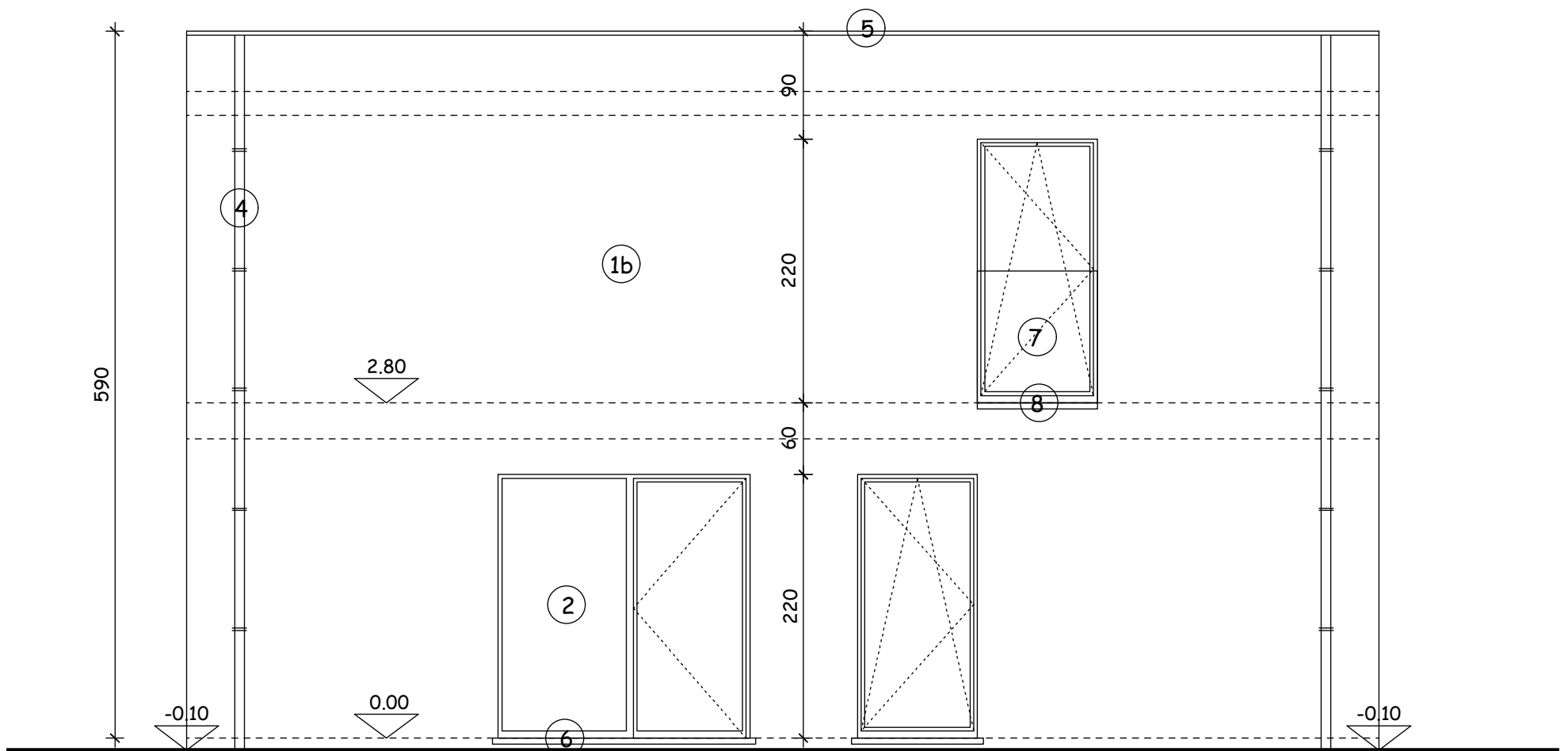

LOT 80
zijgevel rechts (schaal 1/50)

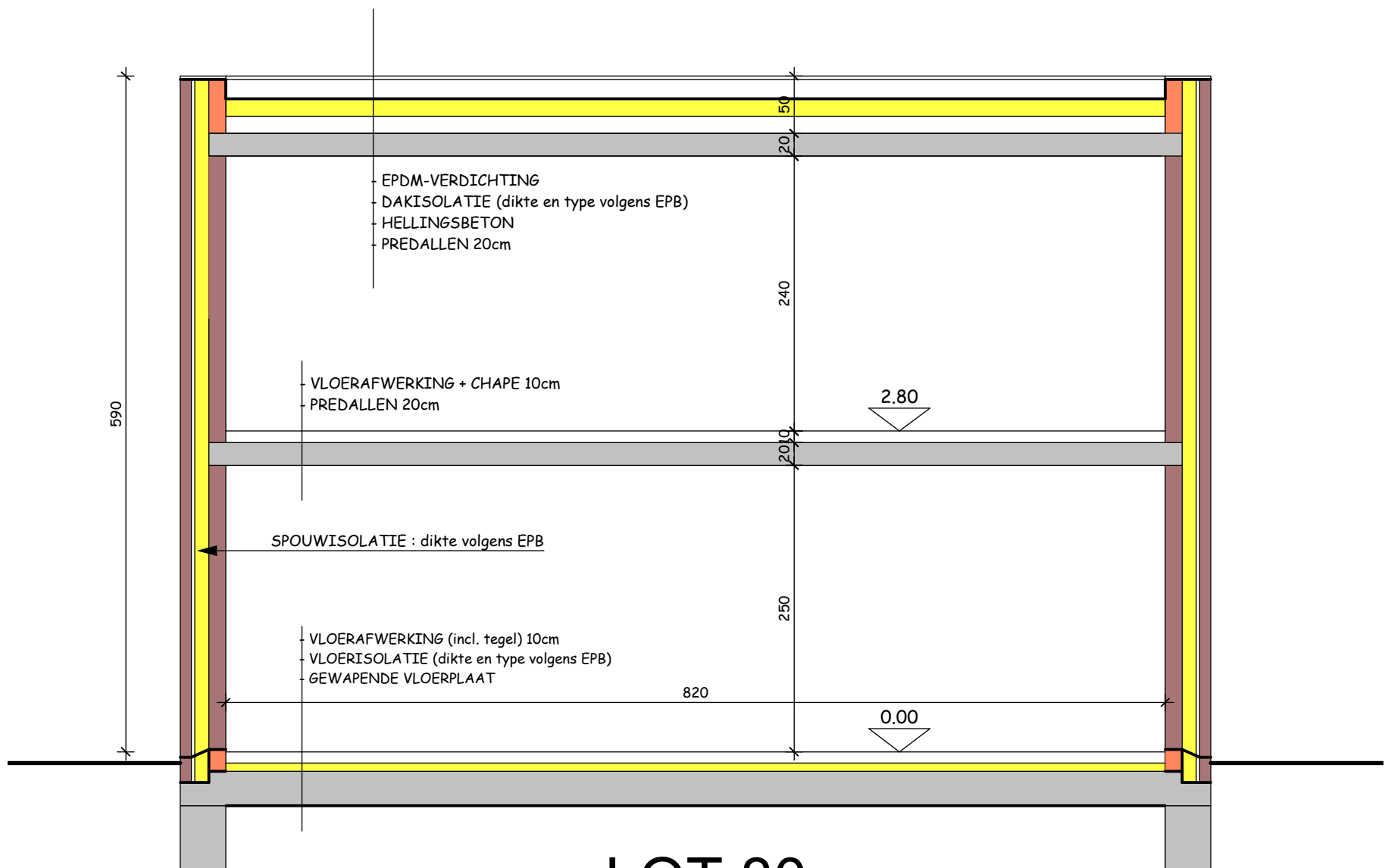

LOT 80

doorsnede (schaal 1/50)

funderingen + stabiliteit volgens studiebureel en sonderingsverslag

LOT 80 (462 m²)
 GELIJKVLOERS
 (schaal 1/50)

-1700-

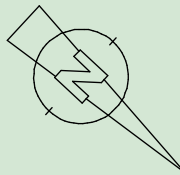

1000

TUIN

1376

-2768-

-2647-

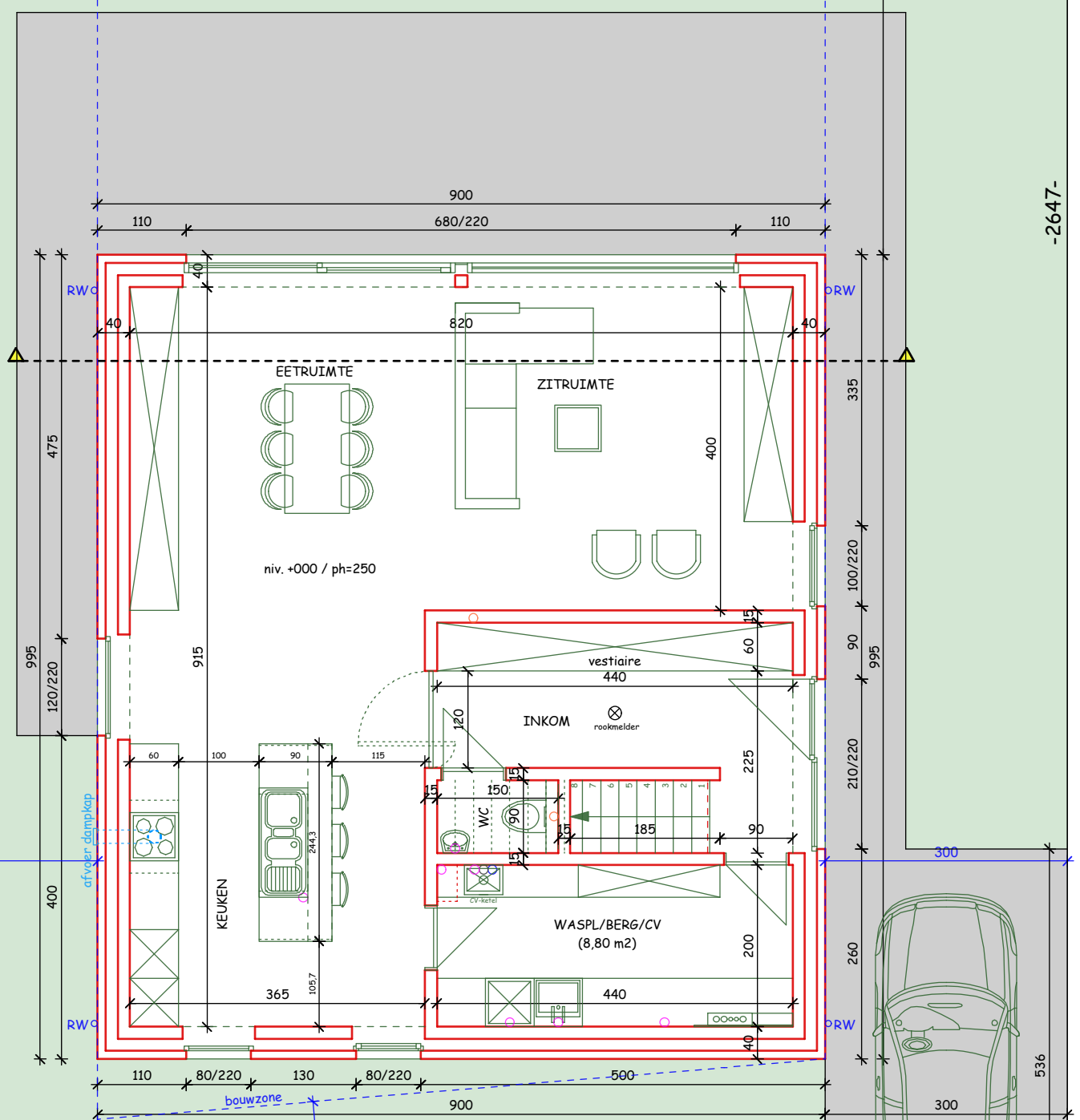

-214-

-1491-